



995C

Combination Lock



Legge's 995C narrow stile mortice combination lock has been designed on the underlying successful design principles of the 990MF Series. Manufactured specifically to meet the requirements of the Australasian market, the 995C provides the specifier and end user with a combination lock for both metal and timber doors. The 995C is ideally suited for commercial and industrial applications where durability and security are of major importance.

The 995C has a high purity die cast zinc alloy case to provide rigidity and precision. Major internal components are made of either stainless steel or sintered steel/copper alloy to provide durability and strength.

The final product has been rigorously tested in accelerated wear tests and testimony to the quality of the 995MF Series is shown through the extensive use in the Australian and New Zealand markets.



Features

- Designed to suit hollow stile metal door sections with internal depths from 39mm and narrow stile timber and french doors
- The multi-function case allows easy conversion of a vestibule lock function (inside handle free) to a combination lock function (both handles locked) by a simple external operation
- The reversible stainless steel latch adjusts for inwards/outwards opening and left/right hand without case disassembly
- The latch is deadlatched by a stainless steel sub-bolt that retracts automatically with the main latch
- The 995MF case will accept bolt-through fixing for 159mm vertical fixing door furniture such as the Legge 5300/5400 Series narrow stile furniture
- Follower will accept 7.6mm-8mm furniture spindles, with no adjustment necessary
- A threaded pin is used for secure cylinder retention
- Designed to be compatible with most electric strikes

Warranties

Mechanical	30 years
------------	----------

Specification guide

Function	Sub-function	Faceplate	Finish	Backset
Combination lock.....L9C	Entry lock.....C1(RH)/C2(LH) Double cylinder door lock.....C7(RH)/C8(LH) Entry lock.....C21(RH)/C22(LH) Turn entry lock.....C23(RH)/C24(LH) Double cylinder door lock.....C27(RH)/C28(LH) Single cylinder door lock.....C31(RH)/C32(LH) Privacy latch.....C33(RH)/C34(LH) Exterior privacy latch.....C41(RH)/C42(LH) Exterior lock.....C49(RH)/C50(LH) Passage latch.....C57(RH)/C58(LH)	Metal fix (short).....blank Wood fix (long).....W	Antique Bronze.....ABZ Chrome Plate.....CP Oil Rubbed Bronze.....ORB Polished Brass.....PB Satin Black Chrome.....SBC Satin Brass.....SB Satin Brass Unlacquered...SBU Satin Chrome Plate.....SCP	23mm.....standard 30mm.....30 38mm.....38

- Function**
Select the desired function e.g. Combination lock L9C
- Sub-function**
Select the required sub-function e.g. C1 Entry lock L9C1
- Faceplate**
Select the desired faceplate e.g. Wood fix L9C1W
- Finish**
Select the desired finish e.g. Satin chrome plate L9C1WS
- Backset**
Select the desired backset e.g. 30mm L9C1WS30

Finishes



ABZ

Antique Bronze



CP

Chrome Plate



ORB

Oil Rubbed
Bronze



PB/PBU

Polished Brass/
Unlacquered



SCP

Satin Chrome
Plate

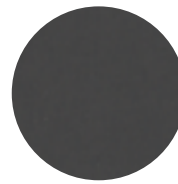

SBC

Satin Black
Chrome



SB/SBU

Satin Brass/
Unlacquered

Testing and Compliance



Security:

Rated S8 and SL8 for physical security, SC7-SC8 for cylinder security and K6 for keying security



Corrosion:

Rated C7 for corrosion



Durability:

Rated D8 for durability

Legge 995C Combination Lock

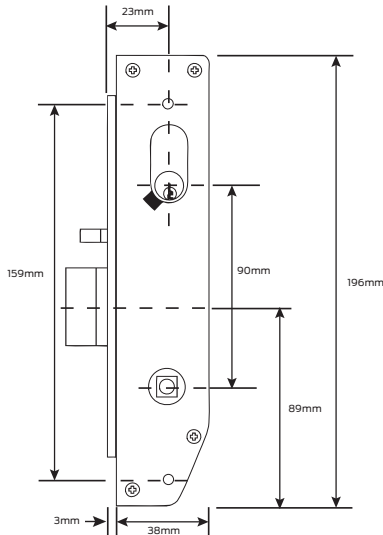

- Key or turn locks or unlocks both handles simultaneously
- Automatic deadlocking by closing door
- Reversible bolt and function

Specifications

Door type	Timber or metal
Door thickness	Timber doors - 32mm to 48mm standard. Extended cylinders, spindles and strike plates available Metal doors - 35mm to 48mm standard. Designed to be used on hollow stile door sections, with a minimum internal depth of 39mm
Lock case	High purity zinc alloy
Outer forend	Satin stainless steel or brass
Bolt	Stainless steel
Sub-bolt	Stainless steel
Spindles	2 split spindles 32mm
Strike plate	Satin stainless steel or brass
Backsets	23mm standard. 30mm and 38mm available
Key cylinder	CC4 6 Pin keyway standard, Schlage C6 pin keyway optional, Schlage SR1 Restricted keyway optional, Schlage Everest Open & Restricted keyways optional

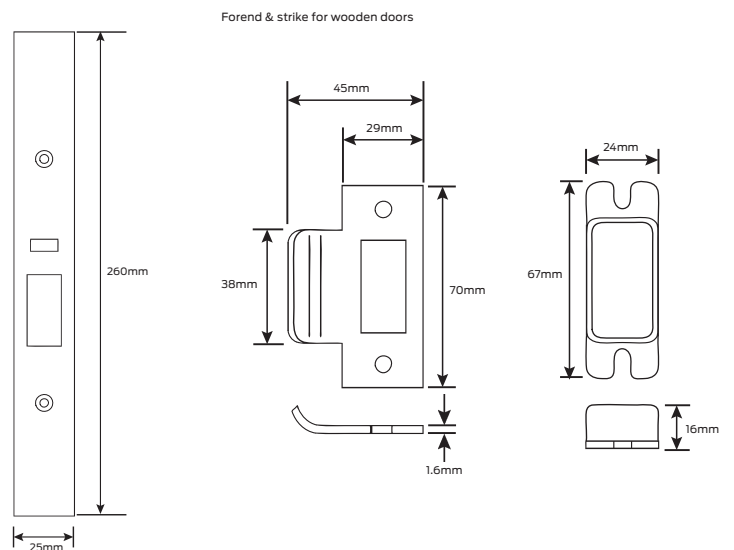
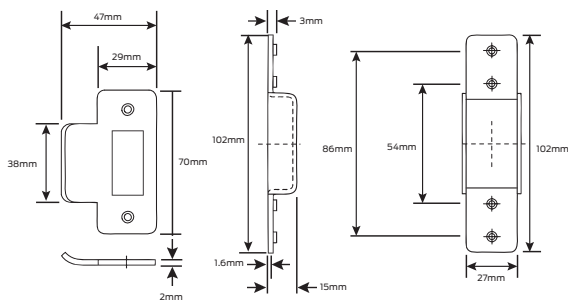
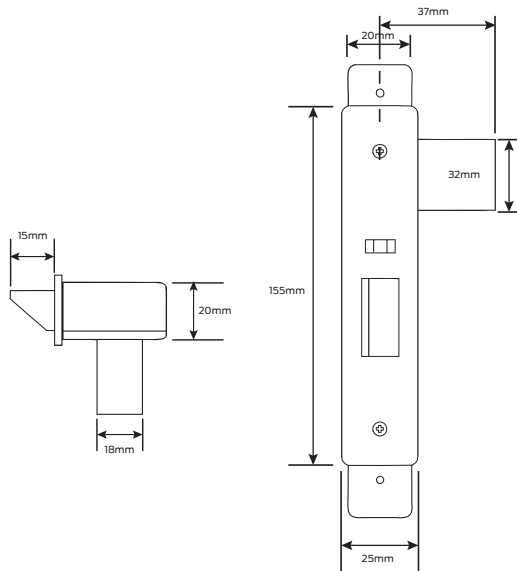

Legge 995C Combination Lock

Sub-function

Cams and adaptors

C1 (RH) C2 (LH) - Entry lock

Outside: Key retracts bolt at all times

Inside: Turn locks and unlocks both handles

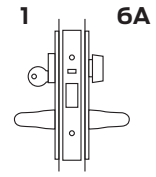

C7 (RH) C8 (LH) - Double cylinder door lock

Outside: Key retracts bolt at all times

Inside: Key locks and unlocks both handles

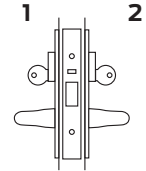

C21 (RH) C22 (LH) - Entry lock

Outside: Key locks and unlocks both handles

Inside: Turn locks and unlocks both handles

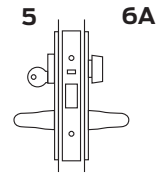

C23 (RH) C24 (LH) - Turn entry lock

Outside: Key locks and unlocks both handles

Inside: Turn operates bolt at all times

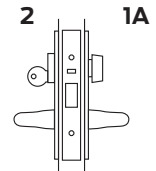

C27 (RH) C28 (LH) - Double cylinder door lock

Outside: Key locks and unlocks both handles

Inside: Key locks and unlocks both handles

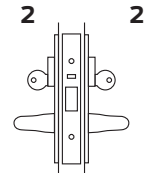

Legge 995C Accessories

Long lipped strike

Strikes for non-standard wooden jambs. Available in 50mm, 60mm, 70mm, 80mm & 90mm (A)

Finishes Satin chrome plate, for special finishes available refer to page 2

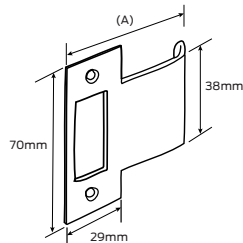

Short lipped strike

Strikes for non-standard jambs

Finishes Satin chrome plate, for special finishes available refer to page 2

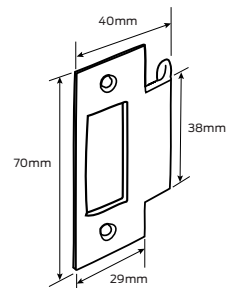

Legge 995C Combination Lock

Sub-function

Cams and adaptors

C31 (RH) C32 (LH) - Single cylinder door lock

Outside: Key locks and unlocks both handles
 Inside: Handle operative except when locked by outside key

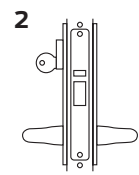

C33 (RH) C34 (LH) - Privacy latch

Outside: Emergency button unlocks both handles
 Inside: Turn locks and unlocks both handles

6A

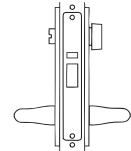

C41 (RH) C42 (LH) - Exterior privacy latch

Outside: Handle operative except when locked by inside turn
 Inside: Turn locks and unlocks both handles

6A

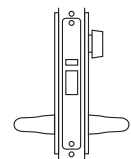

C49 (RH) C50 (LH) - Exterior lock

Outside: Handle operative except when locked by inside key
 Inside: Key locks and unlocks both handles

2

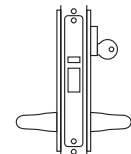

C57 (RH) C58 (LH) - Passage latch

Outside: Always operative
 Inside: Always operative

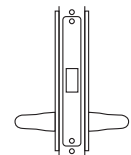

Legge 995C Cams and cam adaptors



1A (with adaptor)

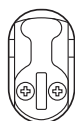

2



5



6A (with adaptor)

