



990MF Series

Locks & latches



Fire Rated: Tested on fire door assemblies in accordance with Australian Standards, refer fire door manufacturer for specific approval details

Legge's 990MF Series of multi-functional mortice locks and latches have been designed specifically to meet the requirements of the Australasian market. With an extensive range of lock functions, the 990MF Series has the right function to meet your specific needs. The 990MF Series is ideally suited for commercial, industrial, institutional and government buildings, where durability and security are of major importance.

The 990MF Series has a high purity die cast zinc alloy case to provide rigidity and precision. Major internal components are made of either stainless steel or sintered steel/copper alloy to provide durability and strength.

The final product has been rigorously tested in accelerated wear tests and testimony to the quality of the 990MF Series is shown through the extensive use in the Australian and New Zealand markets.

Features

- Multi-function case allows easy conversion of a vestibule lock function (inside handle free) to a combination lock function (both handles locked) by a simple external operation
- Reversible stainless steel latch adjusts for inwards/outwards opening and left/right hand without case disassembly
- Standard lock suitable for doors 32mm to 50mm thick. Extended cylinders, spindles and strike plates available to accommodate thicker doors and wider jambs
- 990MF case will accept bolt-through fixing for 50.8mm diagonal and 38mm-41mm horizontal fixing door furniture
- Follower will accept 7.6mm-8mm furniture spindles, with no adjustment necessary
- A threaded pin is used for secure cylinder retention
- Designed to be compatible with most electric strikes
- The 30 year warranty provides specifiers and users with assured quality and performance

Specification guide

Function	Sub-function	Finish	Backset
Vestibule..... L9V	refer following pages	Chrome plate..... CP	60mm..... standard
Combination..... L9C		Polished brass..... PB	70mm.....70
CD series.....L9CD		Satin chrome plate..... SCP	89mm..... 89
Nightlatch..... L9N			127mm..... 127
Deadlock..... L9D			
Sliding door..... L9S			

1. Function
Select the desired function e.g. Vestibule lock L9V
2. Sub-function
Select the required sub-function e.g. V31 Office/classroom locking latch L9V31
3. Finish
Select the desired finish e.g. Satin chrome plate L9V31SCP
4. Backset
Nominate non-standard backset if required e.g. 70mm L9V31SCP70

Legge 990 V Series Vestibule Lock

- Inside handle always operative
- Automatic deadlocking by closing door
- Reversible bolt and function

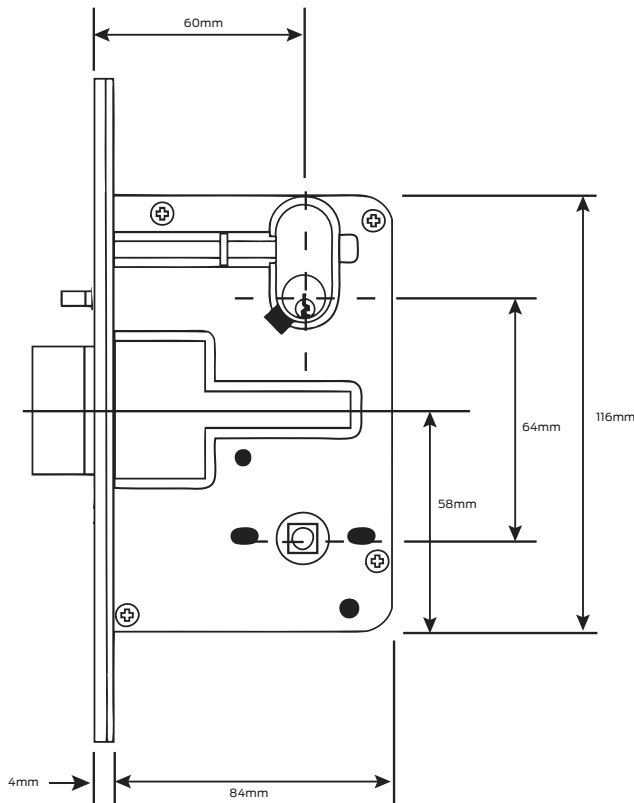

Specifications

Door type	Timber or metal
Door thickness	32mm to 50mm standard, extended cylinders, spindles and strike plates available to accommodate thicker doors
Lock case	High purity zinc alloy
Outer forend	Stainless steel or brass
Inner forend	Stainless steel
Bolt	Stainless steel
Sub-bolt	Stainless steel
Spindles	2 split spindles 32mm
Strike plate	Stainless steel or brass 45mm standard, 40mm, 50mm, 60mm, 70mm, 80mm & 90mm available
Backsets	60mm standard, 70mm, 89mm and 127mm available
Key cylinder	C4 6 pin keyway standard, Schlage C6 pin keyway optional, Schlage E6 pin keyway optional, Schlage Everest D keyway optional
Finishes	Chrome plate, polished brass, satin chrome plate
Warranty	30 year mechanical

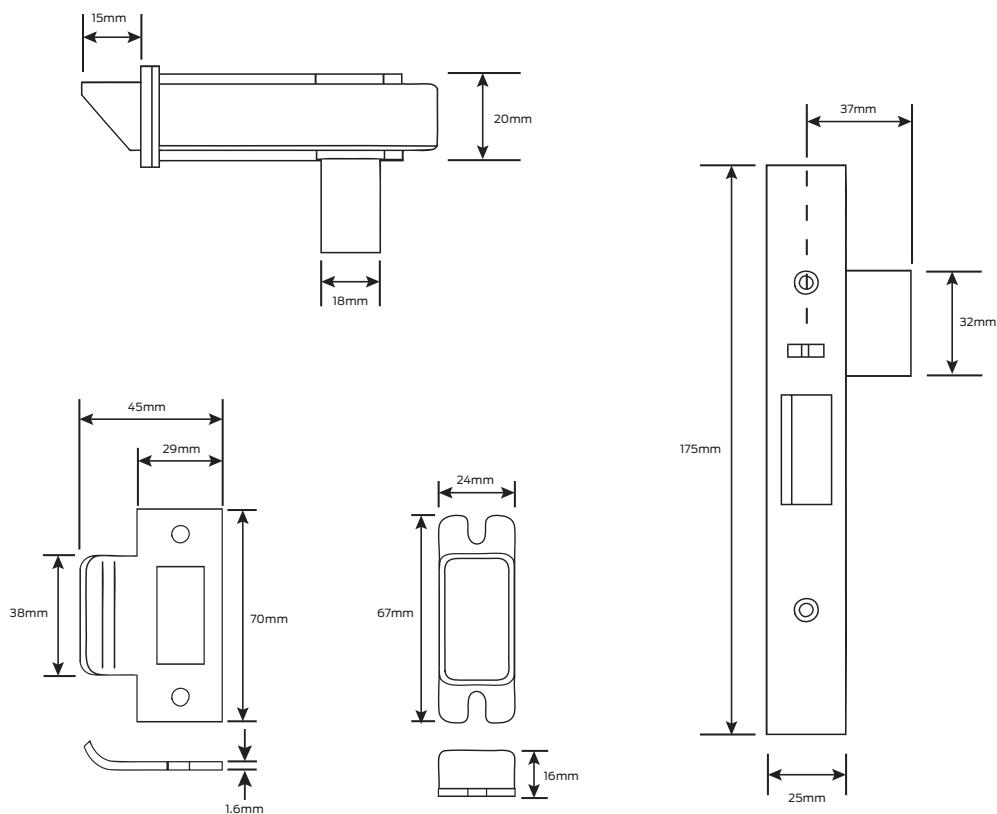

Legge 990 V Series Vestibule Lock

Sub-function

Cams and adaptors

V1 (RH) V2 (LH) - Vestibule lock

Outside: Key operates bolt at all times. Handle operative except when locked by inside turn
 Inside: Turn locks and unlocks outside handle. Handle always operative

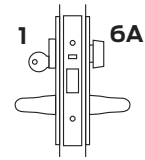

V7 (RH) V8 (LH) - Exterior & exit lock

Outside: Key operates bolt at all times. Handle operative except when locked by inside key
 Inside: Key locks and unlocks outside handle. Handle always operative

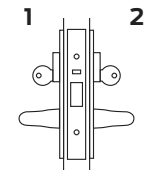

V9 (RH) V10 (LH) - Storeroom lock

Outside: Key operates bolt at all times. Handle always inoperative
 Inside: Handle always operative

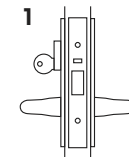

V11 (RH) V12 (LH) - Single action lock

Outside: Key operates bolt at all times
 Inside: Handle always operative

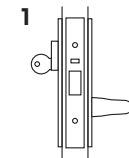

V21 (RH) V22 (LH) - Vestibule lock

Outside: Operative except when locked by outside key or inside turn
 Inside: Turn locks and unlocks outside handle. Handle always operative

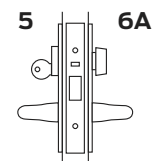

V25 (RH) V26 (LH) - Anti-lockout Lock

Outside: Key locks and unlocks handle. Handle operative except when locked by outside key or inside turn. Closing door or operating inside handle will unlock mechanism and make the outside handle operative
 Inside: Turn locks and unlocks outside handle. Handle always operative

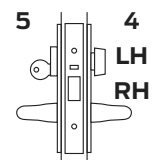

Legge 990 V Series Vestibule Lock

Sub-function

Cams and adaptors

V29 (RH) V30 (LH) - Classroom lock

Outside: Key locks and unlocks handle. The reverse turn of the key retracts the bolt.
 Handle operative except when locked by outside key
 Inside: Handle always operative

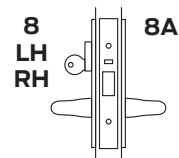

V31 (RH) V32 (LH) - Office/classroom locking latch

Outside: Key locks and unlocks handle. Handle operative except when locked by outside key
 Inside: Handle always operative

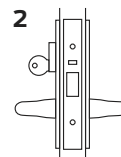

V41 (RH) V42 (LH) - Exterior & exit lock

Outside: Handle operative except when locked by inside turn
 Inside: Turn locks and unlocks outside handle. Inside handle always operative

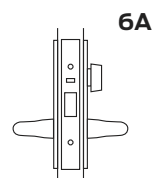

V49 (RH) V50 (LH) - Exterior & exit lock

Outside: Handle operative except when locked by inside key
 Inside: Key locks and unlocks outside handle. Inside handle always operative

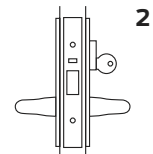

V55 (RH) V56 (LH) - Exit latch

Outside: Handle always inoperative
 Inside: Handle always operative

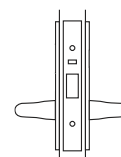

Legge 990 C Series Combination Lock

- Key or turn locks or unlocks both handles simultaneously
- Automatic deadlocking by closing door
- Reversible bolt and function

Specifications

Door type	Timber or metal
Door thickness	32mm to 50mm standard, extended cylinders, spindles and strike plates available to accommodate thicker doors
Lock case	High purity zinc alloy
Outer forend	Stainless steel or brass
Inner forend	Stainless steel
Bolt	Stainless steel
Sub-bolt	Stainless steel
Spindles	2 split spindles 32mm
Strike plate	Stainless steel or brass 45mm standard. 40mm, 50mm, 60mm, 70mm, 80mm & 90mm available
Backsets	60mm standard, 70mm, 89mm and 127mm available
Key cylinder	C4 6 pin keyway standard, Schlage C6 pin keyway optional, Schlage E6 pin keyway optional, Schlage Everest D keyway optional
Finishes	Chrome plate, polished brass, satin chrome plate
Warranty	30 year mechanical

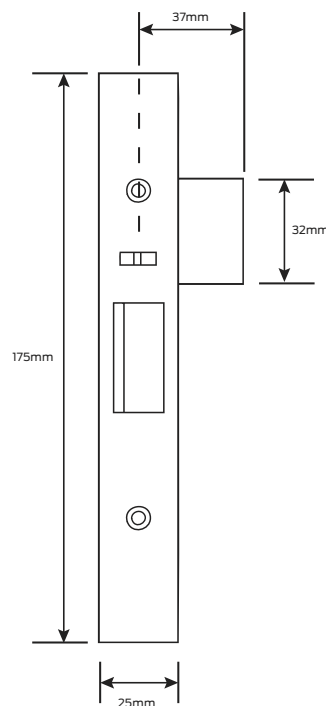
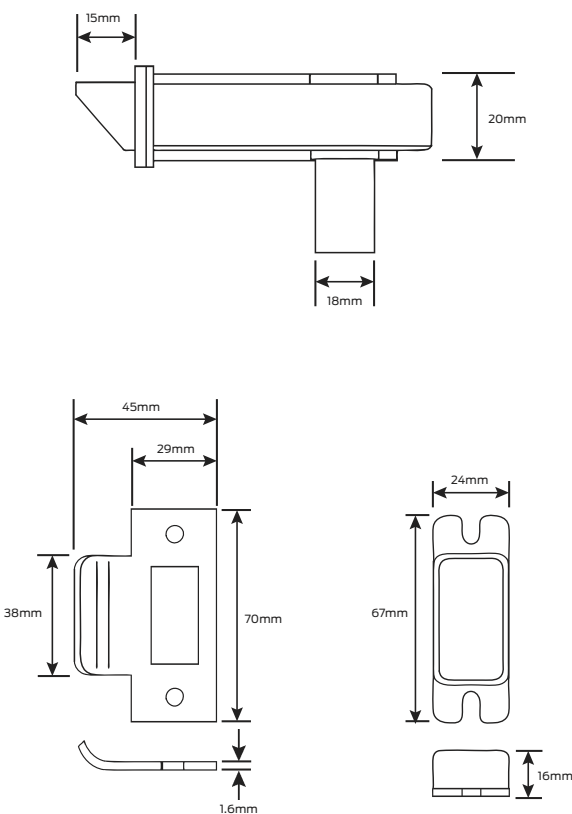
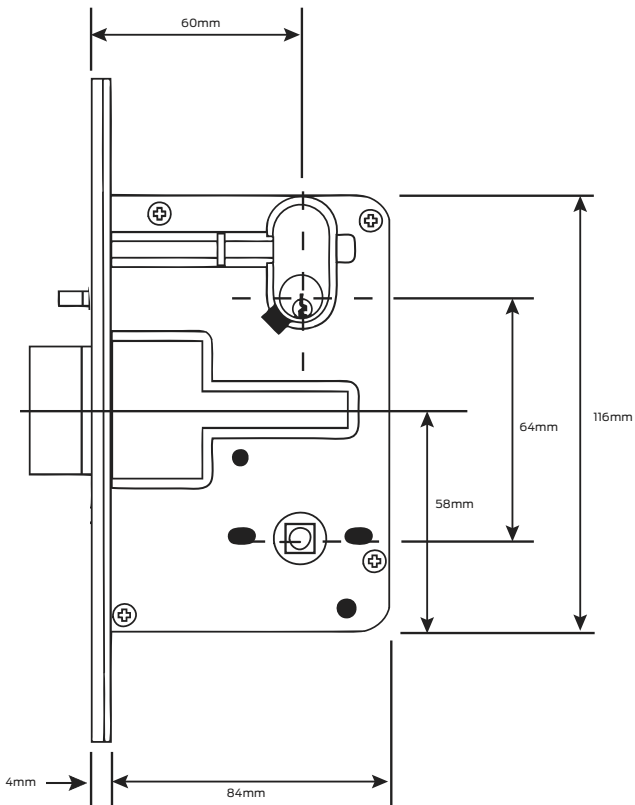

Legge 990 C Series Combination Lock

Sub-function

Cams and adaptors

C1 (RH) C2 (LH) - Entry lock

Outside: Key operates bolt at all times. Both handles operative except when locked by inside turn
 Inside: Turn locks and unlocks both handles

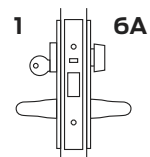

C7 (RH) C8 (LH) - Glass door lock

Outside: Key operates bolt at all times. Both handles operative except when locked by inside key
 Inside: Key locks and unlocks both handles

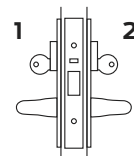

C21 (RH) C22 (LH) - Entry lock

Outside: Both handles operative except when locked by outside key or inside turn
 Inside: Turn locks and unlocks both handles

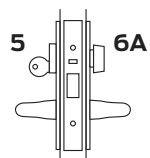

C23 (RH) C24 (LH) - Turn entry lock

Outside: Both handles operative except when locked by outside key
 Inside: Turn operates bolt at all times

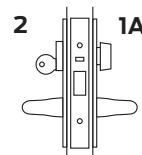

C27 (RH) C28 (LH) - Glass door lock (double cylinder)

Outside: Handle operative except when locked by outside or inside key
 Inside: Handle operative except when locked by inside or outside key

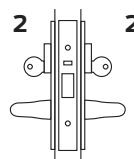

Legge 990 C Series Combination Lock

Sub-function

Cams and adaptors

C31 (RH) C32 (LH) - Glass door lock (Single cylinder)

Outside: Both handles operative except when locked by outside key

Inside: Handle operative except when locked by outside key

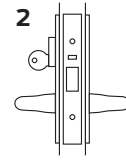

C33 (RH) C34 (LH) - Privacy latch

Outside: Operative except when locked by inside turn. Emergency button unlocks both handles

Inside: Turn locks and unlocks both handles

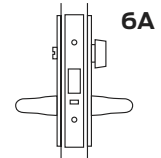

C41 (RH) C42 (LH) - Exterior privacy latch

Outside: Both handles operative except when locked by inside turn

Inside: Turn locks and unlocks both handles

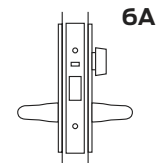

C49 (RH) C50 (LH) - Exterior lock

Outside: Both handles operative except when locked by inside key

Inside: Key locks and unlocks both handles

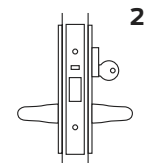

C57 (RH) C58 (LH) - Passage latch

Outside: Always operative

Inside: Always operative

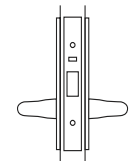

Legge 990 CD Series Combination Lock/Dual Deadlocking

- Key or turn locks or unlocks both handles simultaneously
- Automatic deadlocking by closing door
- Additional deadlocking engaged when locked
- Reversible bolt and function
- Can only be locked when door is in closed position

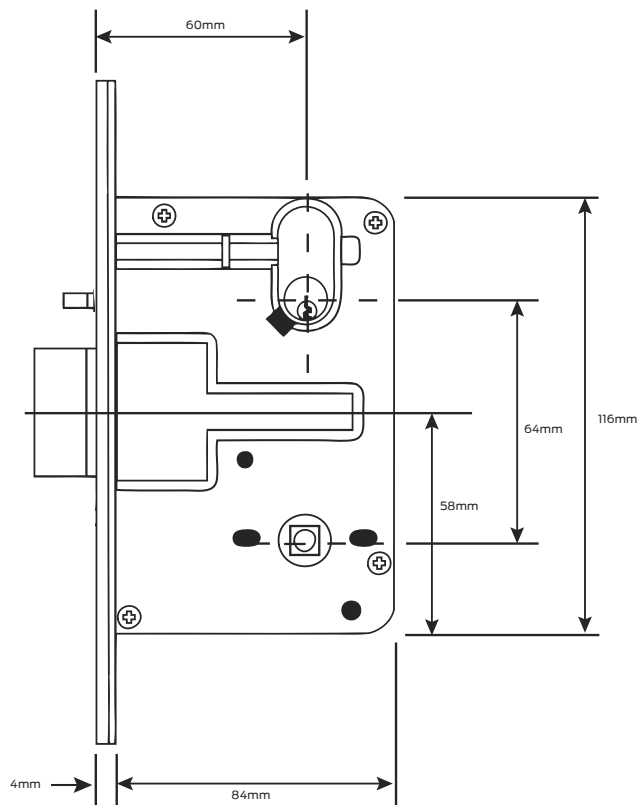

Specifications

Door type	Timber or metal
Door thickness	32mm to 50mm standard. Extended cylinders, spindles and strike plates available to accommodate thicker doors
Lock case	High purity zinc alloy
Outer forend	Stainless steel
Inner forend	Stainless steel
Bolt	Stainless steel
Sub-bolt	Stainless steel
Spindles	2 split spindles 32mm
Strike plate	Stainless steel or brass 45mm standard. 50mm, 60mm, 70mm, 80mm & 90mm available
Backsets	60mm standard. 70mm, 89mm and 127mm available
Key cylinder	C4 6 pin keyway standard, Schlage C6 pin keyway optional, Schlage E6 pin keyway optional, Schlage Everest D keyway optional
Finishes	Chrome plate, polished brass, satin chrome plate
Warranty	30 year mechanical

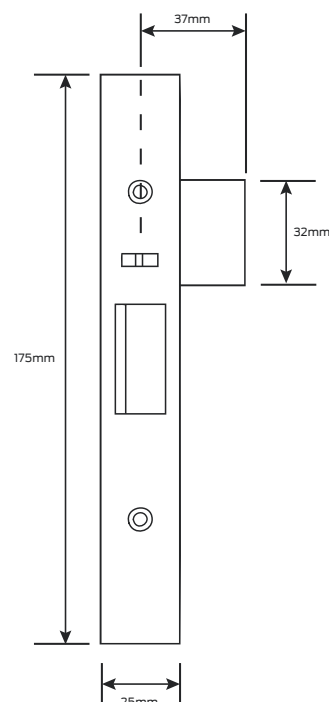
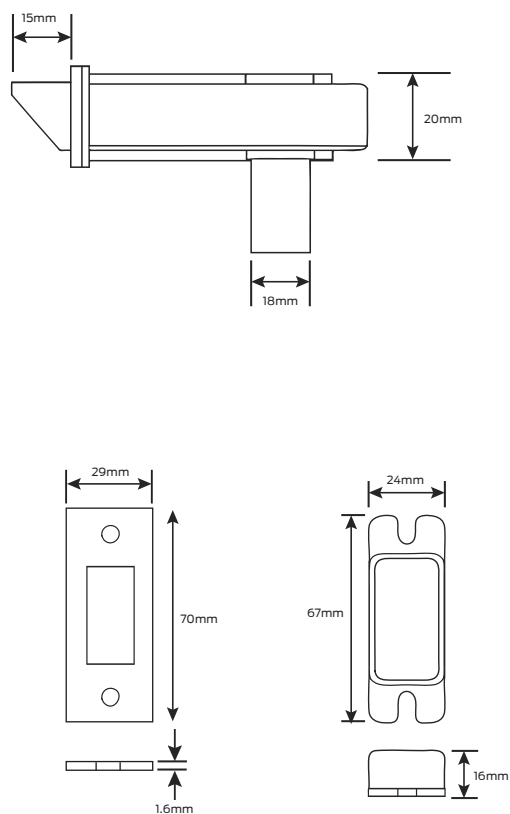

Legge 990 CD Series Combination Lock/Dual Deadlocking

Sub-function

Cams and adaptors

CD21 (RH) CD22 (LH) - Entry lock

Outside: Both handles operative except when locked by outside key or inside turn

Inside: Turn locks and unlocks both handles and disengages dual deadlocking

Caution: Locking can only be engaged when door is in closed position

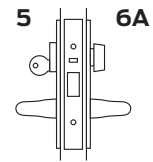

CD27 (RH) CD28 (LH) - Glass door lock (Double cylinder)

Outside: Both handles operative except when locked by either key.

Inside: Key locks and unlocks both handle and disengages dual deadlocking

Caution: Locking can only be engaged when door is in closed position

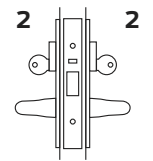

CD31 (RH) CD32 (LH) - Glass door lock (Single cylinder)

Outside: Handle operative except when locked by outside key

Inside: Handle operative except when locked by outside key

Caution: Locking can only be engaged when door is in closed position

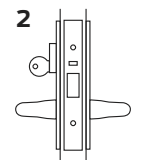

CD41 (RH) CD42 (LH) - Exterior privacy latch

Outside: Both handles operative except when inside turn locked

Inside: Turn locks and unlocks both handles and bolt. Turn also locks bolt

Caution: Locking can only be engaged when door is in closed position

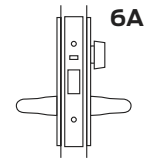

CD49 (RH) CD50 (LH) - Glass door lock

Outside: Both handles operative except when locked by inside key

Inside: Key locks and unlocks both handles and disengages dual deadlocking

Caution: Locking can only be engaged when door is in closed position

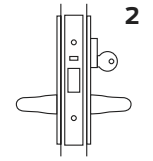

Legge 990 N Series Nightlatch

- Latch operated by key or turn
- Automatic deadlocking by closing door
- Hold back by turn

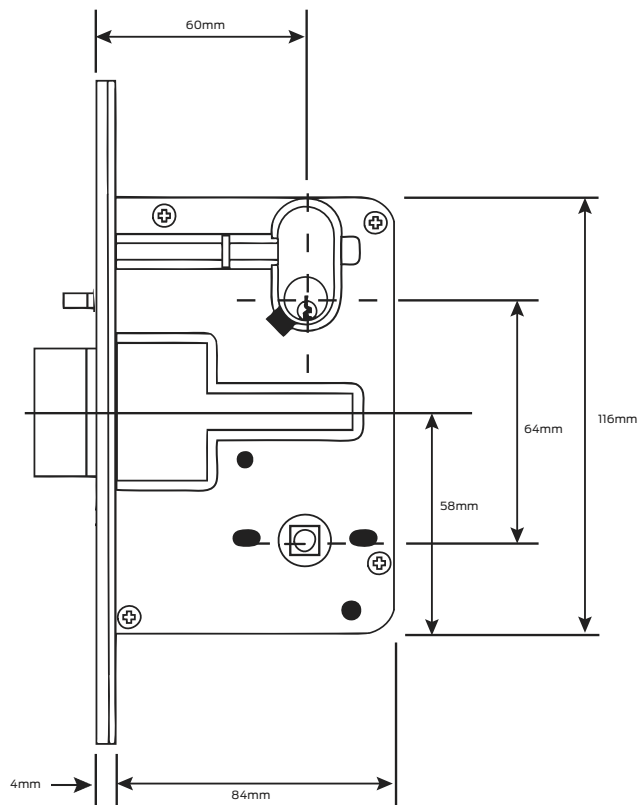

Specifications

Door type	Timber or metal
Door thickness	32mm to 50mm standard. Extended cylinders, and strike plate available to accommodate thicker doors
Lock case	High purity zinc alloy
Outer forend	Stainless steel or brass
Inner forend	Stainless steel
Bolt	Stainless steel
Sub-bolt	Stainless steel
Strike plate	Stainless steel or brass 45mm standard. 40mm, 50mm, 60mm, 70mm, 80mm & 90mm available
Backsets	60mm standard. 70mm, 89mm and 127mm available
Key cylinder	C4 6 pin keyway standard, Schlage C6 pin keyway optional, Schlage E6 pin keyway optional, Schlage Everest D keyway optional
Finishes	Chrome plate, polished brass, satin chrome plate
Warranty	30 year mechanical

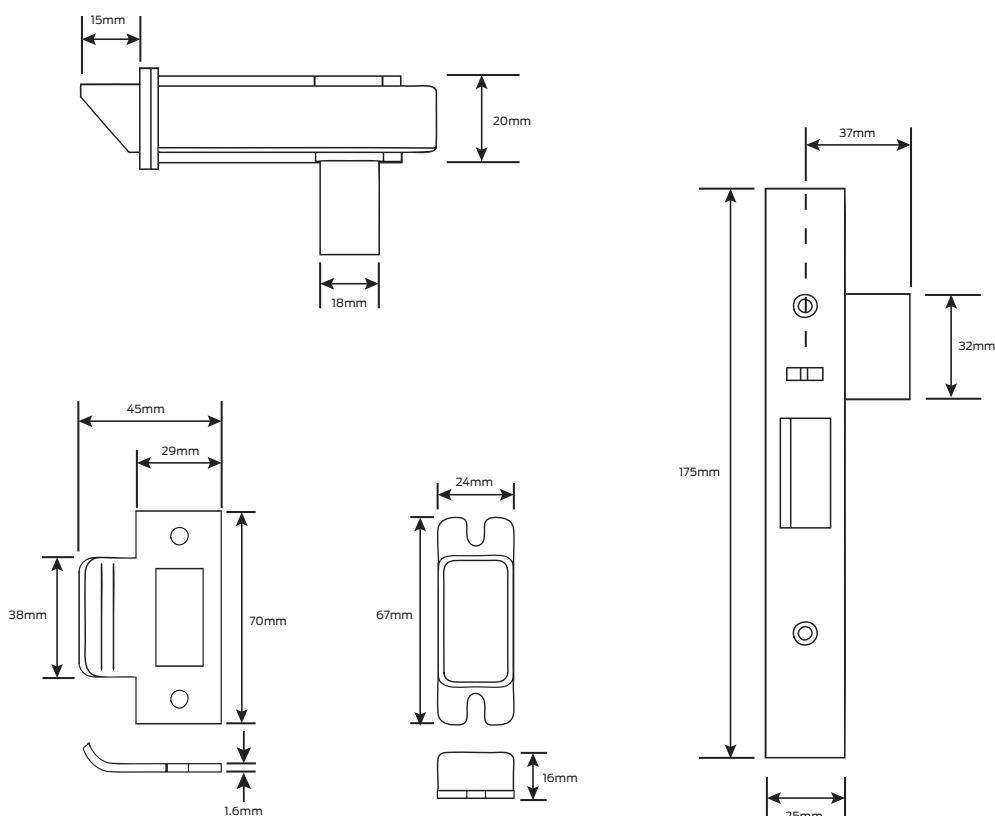

Legge 990 N Series Nightlatch

Sub-Function

Cams and adaptors

N1 (RH) N2 (LH) - Nightlatch

Outside: Key operates bolt

Inside: Turn operates bolt and hold back function

To engage hold back function, manually depress latch, rotate turn towards latch and then release latch

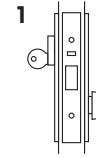

N3 - Communicating door latch

Outside: Key operates bolt

Inside: Key operates bolt

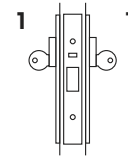

N5 (RH) N6 (LH) - Cylinder latch

Outside: Key operates bolt

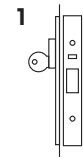

N7 (RH) N8 (LH) - Exit door latch

Inside: Turn operates bolt and hold back function

To engage hold back function, manually depress latch, rotate turn towards latch and then release latch



N9 (RH) N10 (LH) - Fire door nightlatch

Outside: Key operates bolt

Inside: Turn operates bolt

No hold back function

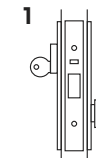

Legge 990 D Series Deadlock

- Deadbolt operated by key or turn

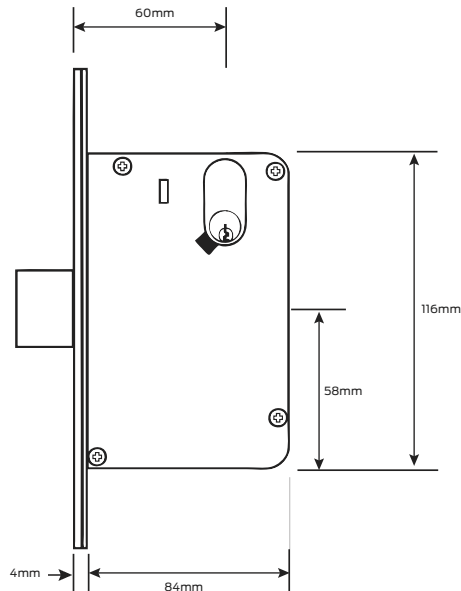

Specifications

Door type	Timber or metal
Door thickness	32mm to 50mm standard. Extended cylinders available to accommodate thicker doors
Lock case	High purity zinc alloy
Outer forend	Stainless steel or brass
Inner forend	Stainless steel
Bolt	One piece sintered stainless steel
Strike plate	Stainless steel or brass
Backset	60mm
Key cylinder	C4 6 pin keyway standard, Schlage C6 pin keyway optional, Schlage E6 pin keyway optional, Schlage Everest D keyway optional
Finishes	Chrome plate, polished brass, satin chrome plate
Warranty	30 year mechanical

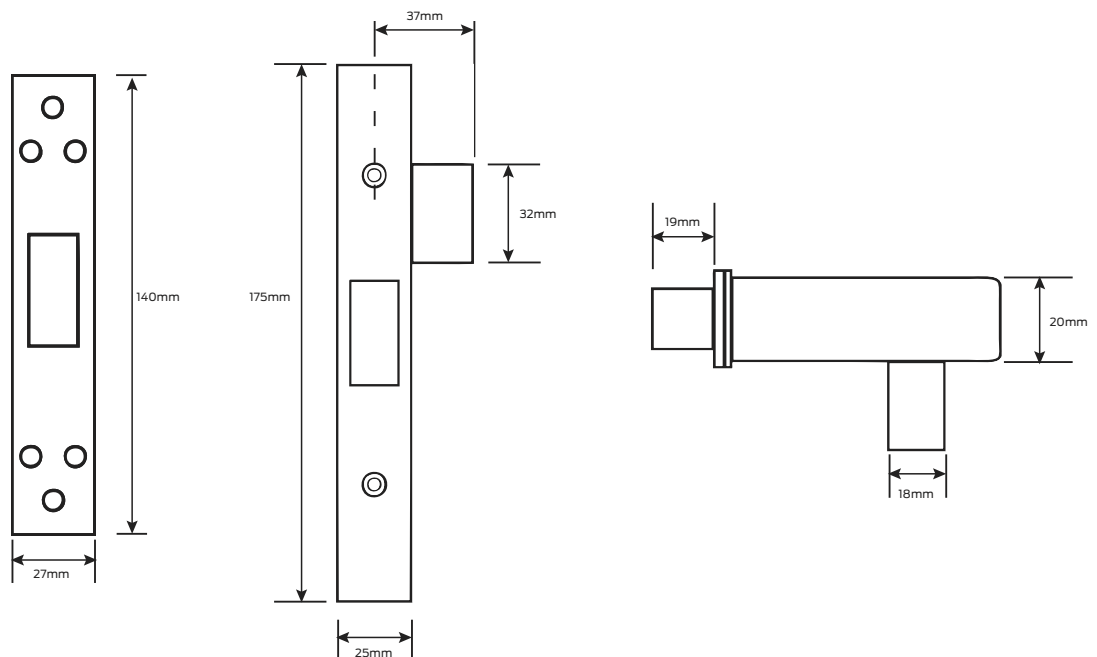

Legge 990 D Series Deadlock

Sub-function

Cams and adaptors

D1 - Entry deadlock

Outside: Key operates bolt
 Inside: Turn operates bolt

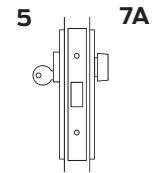

D3 - Glass door deadlock

Outside: Key operates bolt
 Inside: Key operates bolt

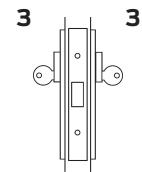

D5 - Lock-up shop deadlock

Outside: Key operates bolt

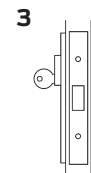

D7 - Exit deadlock

Inside: Turn operates bolt

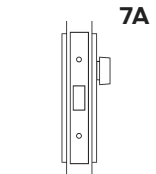

D9 (RH) D10 (LH) - Institutional deadlock

Outside: Key operates bolt
 Inside: Turn operates bolt but slips when key operates cylinder
 Note: This lock is made to order and supplied with modified furniture

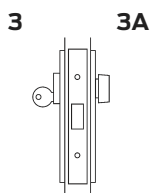

D11 (RH) D12 (LH) - Escape deadlock

Outside: Key operates bolt
 Inside: Turn retracts bolt only, turn cannot throw bolt

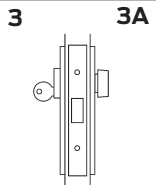

Legge 990 S Series Sliding Door Lock

- Claw bolt operated by key or turn

Specifications

Door type	Timber or metal
Door thickness	32mm to 50mm standard. Extended cylinders available to accommodate thick doors
Lock case / chassis	High purity zinc alloy
Outer forend	Stainless steel or brass
Inner forend	Stainless steel
Bolt	One piece sintered stainless steel
Strike plate	Stainless steel or brass
Backsets	60mm
Key cylinder	C4 6 pin keyway standard, Schlage C6 pin keyway optional, Schlage E6 pin keyway optional, Schlage Everest D keyway optional
Finishes	Chrome plate, polished brass, satin chrome plate
Warranty	30 year mechanical

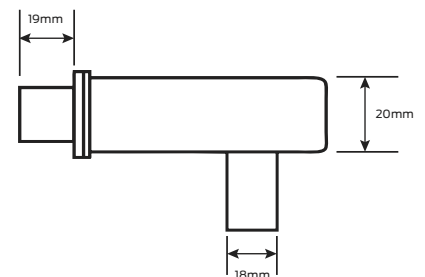
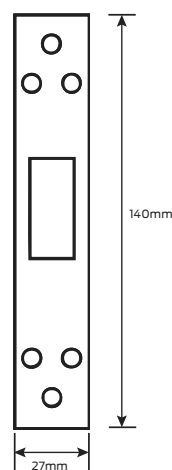
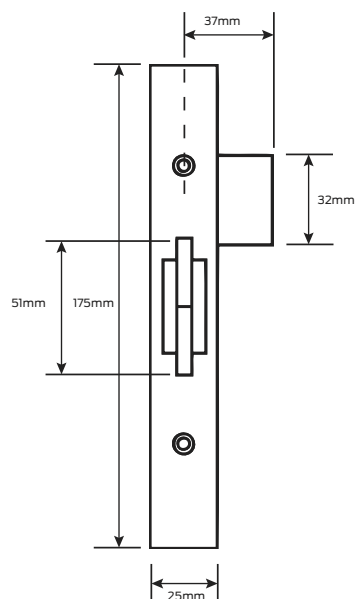
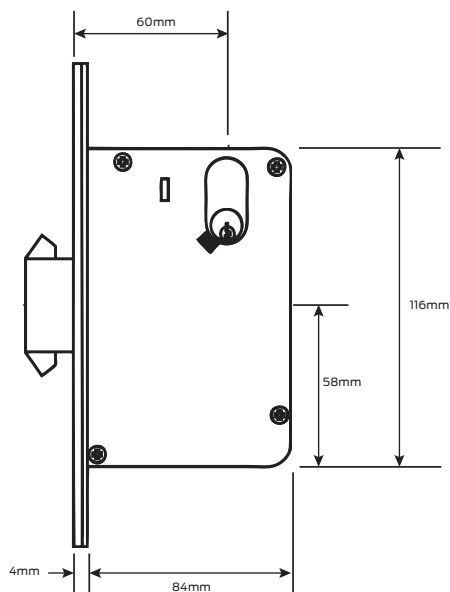

Legge 990 S Series Sliding Door Lock

Sub-function

Cams and adaptors

S1 - Sliding door lock

Outside: Key operates bolt
 Inside: Turn operates bolt

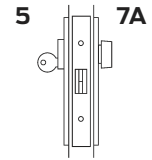

S3 - Glass door sliding deadlock

Outside: Key operates bolt
 Inside: Key operates bolt

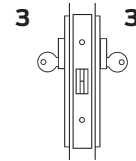

S5 - Lock-up shop sliding door deadlock

Outside: Key operates bolt

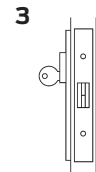

S7 - Exit sliding door deadlock

Inside: Turn operates bolt

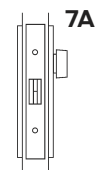

S33 - Sliding door privacy latch

Outside: Emergency button operates bolt
 Inside: Turn operates bolt

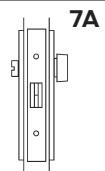

Legge 990MF Cams and Cam Adaptors

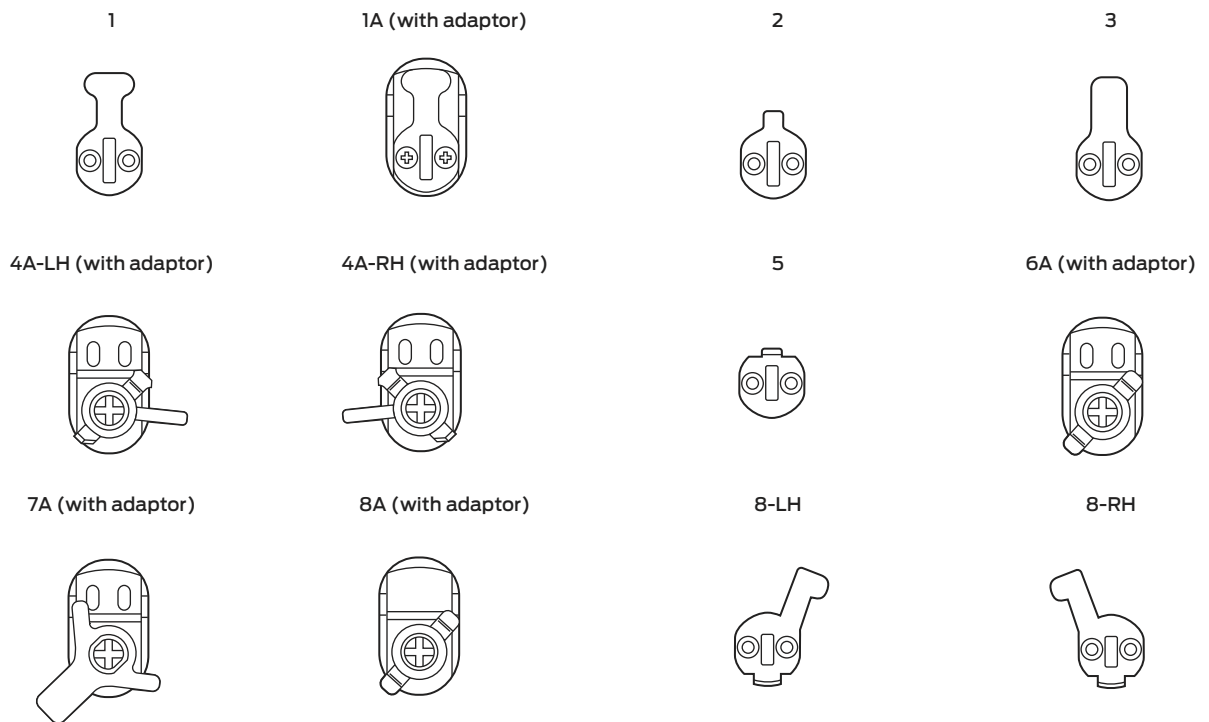

Legge 990MF Series accessories

R13 Rebate kit for V, C, CD, N Series

This kit adapts latches and strikes for 13mm rebated door preparations
Finishes: Chrome plate, polished brass, satin chrome plate

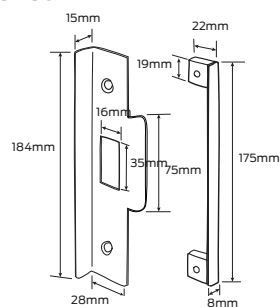

Long lipped strike

Strikes for non-standard jambs.
 Available in 50mm, 60mm, 70mm, 80mm & 90mm (A)
Finishes: Chrome plate, polished brass, satin chrome plate

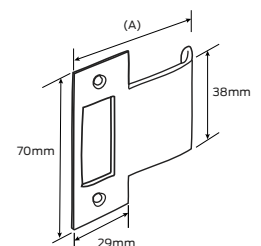

DR13 Rebate kit for D Series

This kit adapts bolts and strikes for 13mm rebated door preparations
Finishes: Chrome plate, polished brass, satin chrome plate

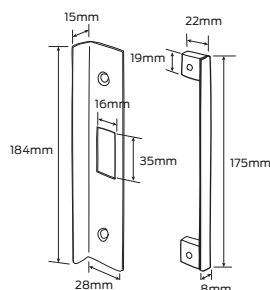

Short lipped strike

Strikes for non-standard jambs
Finish: Chrome plate, polished brass, satin chrome plate

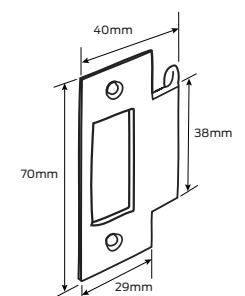



ALLEGION™

PIONEERING SAFETY™

We are
Allegion

Briton ■ LCN ■ LEGGE ■ SCHLAGE ■ VON DUPRIN